

1-800-639-2199

Fax (603) 224-2927

Piers Rectangular\30 x 30 Inch Piers (v)

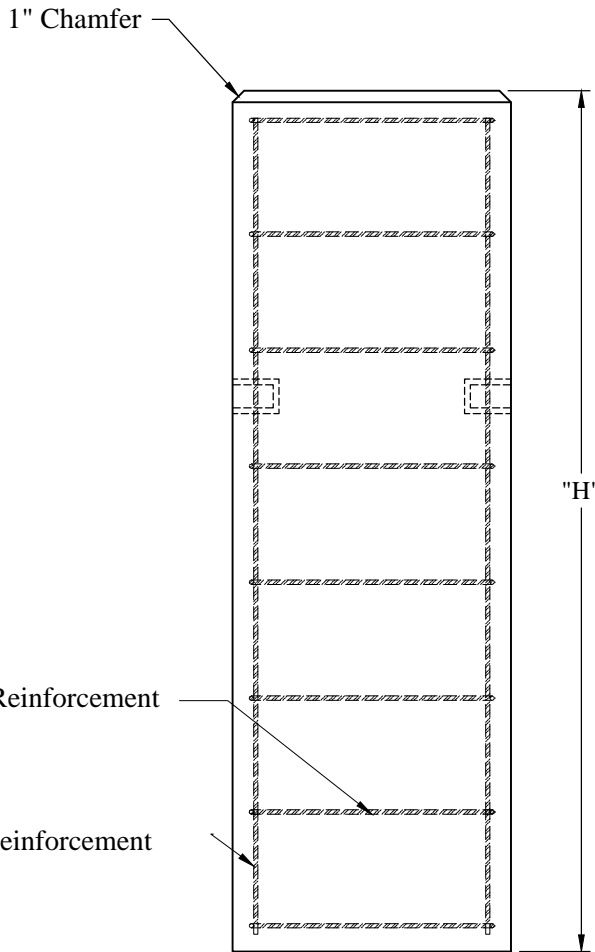
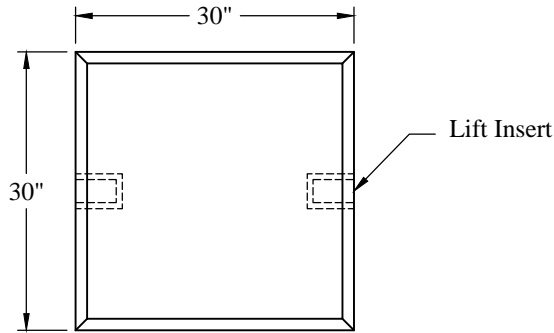

Height	Weight	P/N:
4'-0"	3,700 lbs	PIER-30S4
4'-6"	4,165 lbs	PIER-30S4.5
5'-0"	4,625 lbs	PIER-30S5
5'-6"	5,090 lbs	PIER-30S5.5
6'-0"	5,550 lbs	PIER-30S6
6'-6"	6,015 lbs	PIER-30S6.5
7'-0"	6,475 lbs	PIER-30S7
7'-6"	6,940 lbs	PIER-30S7.5
8'-0"	7,400 lbs	PIER-30S8
8'-6"	7,865 lbs	PIER-30S8.5
9'-0"	8,325 lbs	PIER-30S9
9'-6"	8,790 lbs	PIER-30S9.5
10'-0"	9,250 lbs	PIER-30S10
10'-6"	9,715 lbs	PIER-30S10.5
11'-0"	10,175 lbs	PIER-30S11

General Notes

1. Concrete: $f_c = 4,000$ PSI @ 28 Days Minimum
2. Reinforcing Steel Conforms to Latest ASTM Specifications:
ASTM A615 Grade 60 Rebar Black Deformed Bars

Phoenix
Precast
Products

30" x 30"
Pier

Phoenix Precast Products

Phoenix Precast Products